

MEGA LITE

outshine
PIXEL STRIP Q360

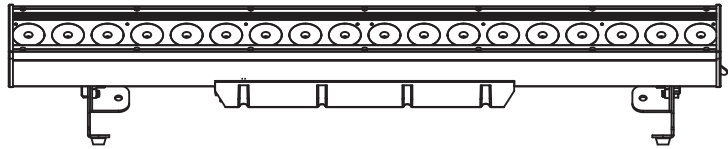

USER MANUAL

Table of Contents

Safety Information	2
What's Included	2
Specifications	3
Main Power Connection	4
DMX Connection	4
Menu Settings	5
Size and Weight	7
DMX Profiles	8
Installation	9
Parts and Accessories	9
Warranty	10
Customer Service	11



Read all cautions and warnings
prior to operation of this
equipment

Protection Against Fire



1. Maintain a minimum of 2 foot distance from any type of flame.
2. Fixture is designed for indoor and outdoor use.
3. Do not install the unit too close to a heat source.
4. Make sure cables are properly secured.
5. Maximum surface operating temperature: 130°.

Protection Against Electrical Fire

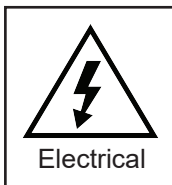

1. Disconnect power before servicing.
2. For connection to main power supply, proceed to page 4.
3. The power supply must be earthed (electronically grounded).
4. This fixture must not be left on for long periods of time.

Protection Against Mechanical Hazards

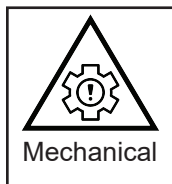

1. Use secondary safety attachment when hanging unit.
2. Use quality clamps or bolts when positioning unit.
3. Do not open unit while it is on. Risk of electrical shock.

Ingress Protection

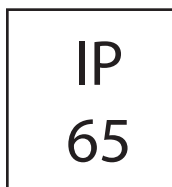

The IP rating is commonly expressed as IP (Ingress Protection) is followed by 2 numbers (i.e. 65) where the numbers define the fixture rating. The first number indicates the size of a particle that can enter the fixture. The second number indicates the extent of protection against water entering the fixture. An IP65 rating in this fixture indicates that dust particles can not enter the fixture. And there is protection against water spray from entering the fixture from any direction.

What is Included

- 1pc Fixture
- 1pc Seetronic SAC3FX to Nema 5-15 cable included
- 1pc Diffusion Filter
- 1pc User Manual

Specifications

Part Numbers

Fixture(s):

7228 - Outshine Pixel Strip Q360

Mechanical Specifications

Housing:	Extruded and Cast Aluminum
Mounting System:	Slide Adjusting Mounting Stands and Clamp Mounts
Power Connection:	Seetronics SAC3MPX Input (Nema 5-15 to SAC3FX-65 cable included)
Signal Connection:	5 Pin XLR In and Out
Lens Angle:	Nominal Beam Angle 17° Nominal Field Angle 29°
Diffusion Angle:	Nominal Beam Angle 109° Nominal Field Angle 157°
Weight:	19lb 12oz
Size:	39.37" X 5.19" X 7.87"

Electrical Specifications

Light Source:	18 X 20W Red, Green, Blue, Warm White
Warm White CCT:	3029K
Power:	Electronic 90-264V AC 50/60
Power Consumption:	293 Watts 2.51 Amps @110V
Power Link:	6 units max @110V

Control & Programming

Protocol:	DMX 512										
RDM:	DMX Address, Channel Mode, Temperature Sensor, Device Hours										
DMX 5 Modes:	<table><tr><td>4 Ch Mode</td><td>Red, Green, Blue, Warm White</td></tr><tr><td>10 Ch Mode</td><td>Dimmer, R, G, B, WW, Strobe, Shutter Macro, Macro Speed, Color Effect, Color Effect Speed</td></tr><tr><td>24 Ch Mode</td><td>R, B, G, WW X 6</td></tr><tr><td>72 Ch Mode</td><td>R, B, G, WW X 18</td></tr><tr><td>82 Ch Mode</td><td>Dimmer, R, G, B, WW, Strobe, Shutter Macro, Macro Speed, Color Effect, Color Effect Speed, R, B, G, WW X 18</td></tr></table>	4 Ch Mode	Red, Green, Blue, Warm White	10 Ch Mode	Dimmer, R, G, B, WW, Strobe, Shutter Macro, Macro Speed, Color Effect, Color Effect Speed	24 Ch Mode	R, B, G, WW X 6	72 Ch Mode	R, B, G, WW X 18	82 Ch Mode	Dimmer, R, G, B, WW, Strobe, Shutter Macro, Macro Speed, Color Effect, Color Effect Speed, R, B, G, WW X 18
4 Ch Mode	Red, Green, Blue, Warm White										
10 Ch Mode	Dimmer, R, G, B, WW, Strobe, Shutter Macro, Macro Speed, Color Effect, Color Effect Speed										
24 Ch Mode	R, B, G, WW X 6										
72 Ch Mode	R, B, G, WW X 18										
82 Ch Mode	Dimmer, R, G, B, WW, Strobe, Shutter Macro, Macro Speed, Color Effect, Color Effect Speed, R, B, G, WW X 18										
Operating Mode:	DMX 512 and Manual Mode via Display										

Main Power Connection

Caution!

1. Do not connect to a dimmer system.
2. This unit has auto switching power supply. It will respond to 90-264VAC 50/60Hz automatically
3. This unit must be earthed. (electronically grounded)

Cable USA	Cable EU	110V	220V
Black	Brown	Live	Live
White	Light Blue	Neutral	Live
Green	Yellow / Green	Ground	Ground

DMX-512 Connection

The fixture is equipped with 5 pin XLR In and Out Sockets. The sockets are wired in parallel. Only use a shielded twisted pair cable designed for 5 pin XLR connectors in order to connect the controller with the fixture or the fixture with another.

DMX 5 Pin XLR - Input / Output

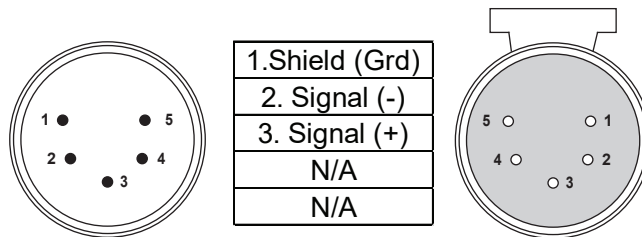

Caution!

On the last fixture the DMX signal needs to be terminated with a terminator. Pre-manufactured terminator are available for purchase from your Mega Lite dealer item #P-DMX-T.

Menu Settings

The control board on the fixture base is your interface to access and control all the functions on the unit. It's LCD display gives you a code view of the options and functions. The following will explain each function.

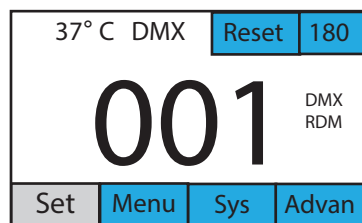
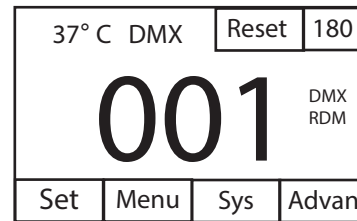

Settings: Settings menu allows you to customize the fixture operational functions

▶ Set	
1 Run Mode	DMX
2 Mode Set	10CH
3 Channel Mode	OFF
4 No DMX Signal	Clear
5 Display	ON
6 Display Lock	ON



Run Mode: Allows you to select operational mode from DMX, Auto , Sound and Manual options

Mode Set: Options for Playback Auto Program

Channel Mode: Will give you the option of operational DMX profile use.

04 CH: Red, Green, Blue, Warm White

10 CH: Dimmer, R,G,B,WW, Strobe, Shutter Macro, Macro Speed, Color Macro, Color Macro Speed

24 CH: R,G,B,WW X6

72 CH: R,G,B,WW X18

82 CH: Dimmer, R,G,B,WW, Strobe, Shutter Macro, Macro Speed, Color Macro, Color Macro Speed, RGBWW X18

No DMX Signal: If DMX Signal is lost=Keep option will hold the last dmx command. Clear will turn all channels to off position

Display: **On:** option will turn display off after no use for 45 seconds
Off: will leave display on

Display Lock: **On:** Requires Password to access Display
Off: No password required

37° C DMX
Reset
180

001

DMX
RDM

Set
Menu
Sys
Advan

Manual: Gives you operational control over the fixture via display

▶ Menu

1 Dimmer	255
2 Red	127
3 Green	000
4 Blue	255
5 White	127
6 Strobe	000

Manual: Select the Channel you wish to adjust. Us the up/down button to select the function setting from 0-255.

Reset
180

001

DMX
RDM

Set
Menu
Sys
Advan

System: Allows you to see the fixtures operational status.

▶ System

1 Vers	BT4L-H240716
2. Stard time	00000:00
3. Use time	00000:48
4. Sys info	▶

System: Fixtures bio's

Reset
180

001

DMX
RDM

Set
Menu
Sys
Advan

Advance: Advance Factory Settings, please reach out to customer service for more information.

Reset
180

001

DMX
RDM

Set
Menu
Sys
Advan

180: Invert Display

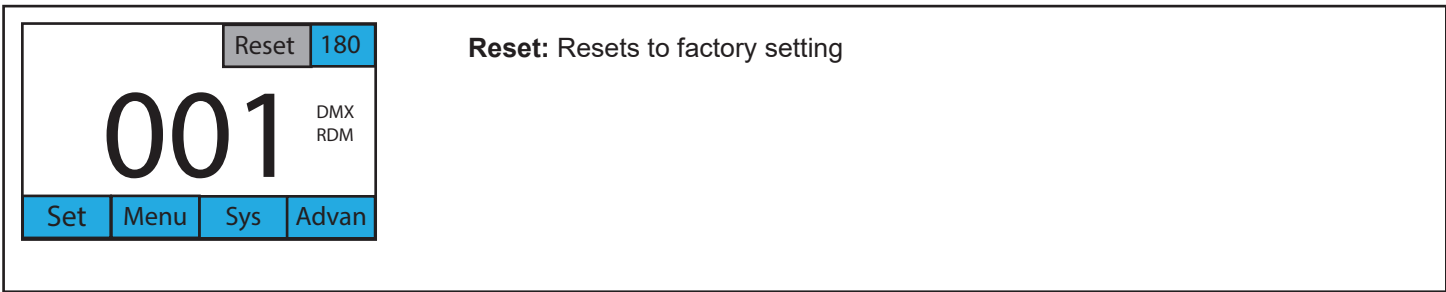

Size and Weight

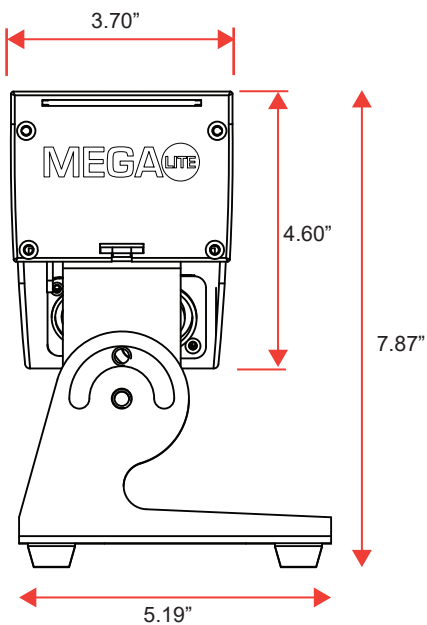
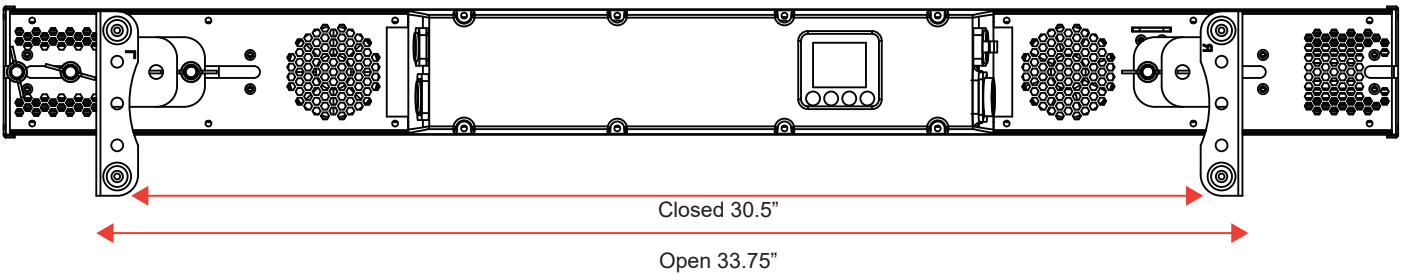
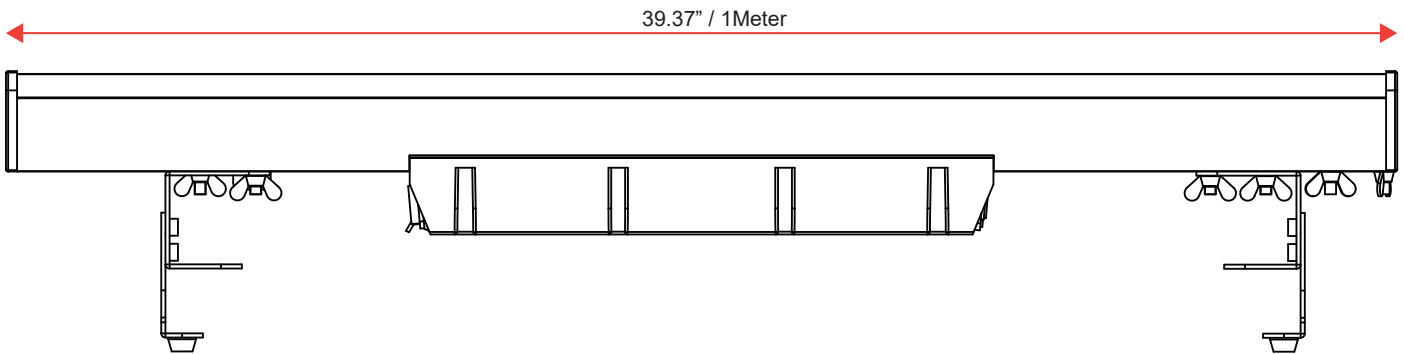

Fixture Size:	39.37" X 5.19" X 7.87"
Fixture Weight:	19lb 12oz
Packaged Size:	41.5" X 6.75" X 8.5"
Packaged Weight:	20lb

DMX Profile

Outshine Pixel Strip Q360

4 Channel Mode	10 Channel Mode	24 Channel Mode	72 Channel Mode	82 Channel Mode	Function	Description	Value	Init Value	
	1			1	Dimmer	Dimmer Off to Full (front leds)	0-255	255	
1	2			2	LED Intensity	Red LED Intensity	0-255	255	
2	3			3	LED Intensity	Green LED Intensity	0-255	255	
3	4			4	LED Intensity	Blue LED Intensity	0-255	255	
4	5			5	LED Intensity	Warm White LED Intensity	0-255	255/0	
	6			6	Strobe (Requires LED Intensity)	No Function	0-9		
						Strobe (slow to fast)	10-99		
						Pulse Strobe (slow to fast)	100-149	0	
						Random Strobe All (slow to fast)	150-199		
						Random Strobe Each (slow to fast)	200-255		
	7			7	Shutter Macro (Requires LED Intensity)	No Function	0-9		
						Macro 1	10-49		
						Macro 2	50-99		
						Macro 3	100-109		
						Macro 4	110-119		
						Macro 5	120-129	0	
						Macro 6	130-139		
						Macro 7	140-149		
						Macro 8	150-159		
						Macro 9	160-169		
						Macro 10	170-179		
						Macro 11	180-189		
						Macro 12	190-199		
						Macro 13	200-209		
						Macro 14	210-219		
						Macro 15	220-227		
						Macro 16	228-255		
	8			8	Macro Speed	Macro Speed (slow to fast)	0-255	0	
						No Function	0-9		
						Macro 1	10-49		
						Macro 2	50-99		
						Macro 3	100-109		
						Macro 4	110-119		
						Macro 5	120-129	0	
						Macro 6	130-139		
	9			9	Color Effect	Macro 7	140-149		
						Macro 8	150-159		
						Macro 9	160-169		
						Macro 10	170-179		
						Macro 11	180-189		
						Macro 12	190-199		
						Macro 13	200-209		
						Macro 14	210-219		
						Macro 15	220-227		
						Macro 16	228-255		
	10			10		Color Effect Speed	Color Effect Speed (slow to fast)	0-255	0
			1	11		LED 1	LED 1 Red	0-255	0
			2	12		LED 1	LED 1 Green	0-255	0
			3	13		LED 1	LED 1 Blue	0-255	0
			4	14		LED 1	LED 1 Warm White	0-255	0
			" "	" "		" "	" "	" "	" "
			69	79		LED 18	LED 18 Red	0-255	0
			70	80	LED 18	LED 18 Green	0-255	0	
			71	81	LED 18	LED 18 Blue	0-255	0	
			72	82	LED 18	LED 18 Warm White	0-255	0	
	1				LED 1,2,3	LED 1,2,3 Red	0-255	0	
	2				LED 1,2,3	LED 1,2,3 Green	0-255	0	
	3				LED 1,2,3	LED 1,2,3 Blue	0-255	0	
	4				LED 1,2,3	LED 1,2,3 Warm White	0-255	0	
					" "	" "	" "	" "	
	21				LED 16,17,18	LED 16,17,18 Red	0-255	0	
	22				LED 16,17,18	LED 16,17,18 Green	0-255	0	
	23				LED 16,17,18	LED 16,17,18 Blue	0-255	0	
	24				LED 16,17,18	LED 16,17,18 Warm White	0-255	0	

Installation

Caution!

1. The Installation must be carried out by an authorized dealer or trained professional.
2. Unit may cause severe injuries, if you have doubts concerning the safety do not install.
3. Unit is to be 24 inches away from flammable materials.
4. Use high quality installation equipment to hang the unit.

When rigging the it is very important that you follow common safety procedures. Rigging requires extensive experience including but not limited to calculating working weight loads, material being used and periodic safety inspections. If you lack these qualifications, do not attempt the installation yourself, instead use a professional structural rigger.

When rigging the unit always be secure with a secondary safety attachment. The installation location of the fixture has got to be built in the way that it can hold 10 times the weight for 1 hour with out any failures. Installation should be checked at least one time a year by a skilled professional.

Cleaning and Maintenance

Installation Maintenance- The operator has to make sure that the unit is operating safely and has the installations and electronics checked by an expert every year.

The following points must be considered during the inspection:

- 1) All screws used for installing the device or part of the device have to be tightly connected and must not be corroded.
- 2) There must not be any deformations on the housing, fixation and installation spots (ceiling, suspension, trussing).
- 3) The electronic power supply cables must not show any damages, material fatigue (e.g. porous cables) or sediments. Further instructions depending on the installation spot and usage have to be adhered by a skilled installer and any safety problems have to be removed.
- 4) Fixture housing must only be cleaned from the outside using only soap and water.

Note: Maintenance and service operations are to be carried out by authorized dealers.

Replacing the power cable: If the power cable of this device becomes damaged, it has to be replaced by authorized dealers or trained professionals only.

Should you have further questions, please contact your dealer.

Parts & Accessories

Item#	Description
7228-LED-RGB	Replacement LED R,G,B,WW
7228-LED-MOD-RGB	LED Module Complete R,G,B, WW
7228-FAN	Fan DAP-701581-2-ADC5V
7228-POW	Power Supply POWSUN USP-401-5 5VDC80 A
7228-PCB-MAI-DRI	Main PCB and Display
7228-GLA	Glass Cover
7228-HOU-MOU	Mounting System with Knob
7228-DIF	Diffusion
7228-HOU-JOI	Joining Hardware

GENERAL TERMS AND CONDITIONS

1. All resellers must have approved and signed Reseller Application on file including their respective state tax information and W-9. Applications are re-evaluated on a fiscal calendar year basis to assure business integrity and tax status.
2. Cash, check, cashiers check, ACH, wire transfer, MasterCard, Visa, Discover and American Express are accepted forms of payment.
3. Past due invoices will be charged 1.5% per month finance charge. Uncollected invoices are subject to be turned over to collection.
4. The reseller will pay all reasonable expenses incurred in the course of collections.
5. The proper venue for litigation will be Bexar County, Texas.
6. Returned checks will be charged a \$50.00 fee.
7. All prices are in U.S. Dollars.
8. All prices and specifications are subject to change without notice, sales order confirmations are emailed and will reflect correct pricing.
9. All terms are insured, monitored, analyzed and approved by Coface USA. Changes in credit line and approved terms can change without notice. Company authorization of credit is based on Coface approvals. Any conflicts or disagreements should be referred to:
650 College Rd. East Suite 2005 Princeton, NJ 08540. 1-609-469-0400. E-mail: cofaceusa@coface.com
10. Returns are subject to 25% restocking charge plus any necessary charges for repair or re-packaging.

SHIPPING TERMS AND CONDITIONS

1. All orders are EXW San Antonio, TX (EXW means that a buyer/reseller incurs the risks for bringing the goods to their final destination). Any deviation needs to be done in writing.
2. UPS ground shipping is the preferred shipping method. Requests for specific carriers may require use of the customer's account number and may incur an additional charge for handling.
3. Drop shipments are subject to all return charges at reseller's expense. Drop shipments are not allowed outside of the territorial United States.
4. No C.O.D. shipments allowed.
5. Returned and undelivered shipment charges are the buyer/reseller's responsibility and will be billed to the buyer/reseller.
6. The freight carrier and company shipping@mega.lighting should be notified upon receipt of damaged freight, discrepancies or non-conformities within 24 hours. Company can assist in making claims with carriers or agents in the event of any loss or damage.

WARRANTY AND SERVICE PROCEDURES

1. All returns require an RMA# (Return Merchandise Authorization number) before returning goods for any reason. For a service or warranty RMA, please email service@mega.lighting or call 210-684-2600. For sales or demo returns, please contact sales@mega.lighting.
2. Case will be created and an RMA notice will be emailed. All units received must have the RMA # included with the unit as well as on the shipping label.
3. All shipping charges are the responsibility of the customer: MEGA Systems, Inc., Service, 18668 HWY 16 N, Helotes, TX 78023.

WARRANTY FOR PRODUCTS PURCHASED BEFORE 2021

Unless otherwise stated in writing, product is covered by a **one year parts and labor** limited warranty and is subject to same limitation listed under the limited warranty exclusions listed below.

WARRANTY FOR PRODUCTS PURCHASED AFTER JANUARY 1, 2021

MEGA SYSTEMS INC ("MSI") hereby warrants to the original purchaser/owner ("Customer"), MSI products to be free of manufacturing defects in material and workmanship, for the warranty periods as defined below from the original purchase invoice date. This warranty applies exclusively to new MSI branded and/or distributed products listed below, purchased from an MSI AUTHORIZED dealer/reseller. This warranty is not transferable and may or may not apply to products sold and/or forwarded outside the United States. Please contact MSI for applicable regional product warranty information. The purchase of MSI product constitutes the Customer's acceptance of all warranty terms and conditions as listed in this limited warranty statement. This warranty provides the Customer with legal rights which may vary from state to state. Please contact MSI regarding warranty questions prior to purchasing.

Product / Series	Warranty Period	Coverage
BATTERY POWERED LED	Six month battery one year all other components	1, 2
MOVING LED, HAZERS	One year	2
OUTDOOR IP RATED LED	Two Year	3
HOUSE LIGHT LED, DECORATIVE LED, COMPACT LED, ICANDY LED, THEATRICAL LED, STROBE WASH LED, FOLLOW SPOT LED, PRODUCTION & HOUSE OF WORSHIP CONTROL, ARCHITECTURAL CONTROL, THEATRICAL CONTROL, DANCE VENUE & MOBILE DJ CONTROL, DIRECT VIEW LED DISPLAYS, AND MV CONTROLLERS	Three Year	4

1. Battery, 183 days six months 2. Parts and Labor, 365 days one year 3. Parts and Labor, 730 days two year 4. Parts and Labor, 1095 days three year

This limited warranty excludes any defects caused by, resulting from or relating to the following:

- Normal wear and tear of lamps, color media, brushes, contact rings, lamp sockets, belts and other parts prone to wear and tear.
- Misuse, abuse, improper handling, accident, alteration or attempts to repair by or on behalf of the owner or any person not authorized by MSI.
- Damage to the product resulting from acts of God, including, but not limited to, earthquakes, hurricanes, tornados, lightning and other natural disasters, fire, explosion, flood, riots, civil disorder or any other cause beyond the reasonable control of MSI.
- Exposure to harsh or excessively corrosive environmental conditions (whether indoors or outdoors), including, but not limited to, extreme temperatures, humidity, atmospheric conditions (including salinity or pressure), radiation (UV, infrared or nuclear), shock and conditions which exceed the product's Ingress Protection ("IP") rating.
- Use of the product in a manner which exceeds the applicable product specification, including, but not limited to, exposure to excessive, insufficient or other voltage conditions.
- Installation or use of the product not in accordance with the technical documentation, MSI guidelines (as may be posted on its website at www.megasystemsinc.com from time to time or otherwise designated by MSI or its brands) or applicable building and electrical codes, regulations and standards.
- Failure to maintain the product in accordance with the technical documentation.
- Natural degradation and color shift of the LED source over the course of normal product use.
- Slight deviations in the specified values of intensity and color that do not affect the functionality of the product.
- Use of the product not for its intended purpose.

All warranty claims are evaluated under the terms of this limited warranty. If a product falls within the warranty period and if, upon examination by MSI it is found to have failed for a covered cause, MSI will, at its sole discretion, repair or replace the defective part or product or reimburse the purchaser a pro-rated portion of the purchase price based on the percentage of the warranty period still remaining as of the date that the returned product was received by MSI. Should a replacement part or product be discontinued or unavailable, MSI reserves the right, in its sole and absolute discretion, to substitute a comparable replacement part or product for the defective part or product. MSI warranty obligation hereunder is limited solely to the repair or replacement of or reimbursement for the particular parts or products determined by MSI to have failed for a covered cause within the warranty period. In no event shall MSI be responsible to replace or reimburse purchaser for any products or portions of a system that MSI determines has not failed for a covered cause within the warranty period, even if such other products or portions of a system are used together with products being repaired or replaced by MSI under this warranty and the repaired product differs in brightness, colors or any other attribute after the repair.

Costs of removal, shipping to MSI or its authorized representative and reinstallation are solely the responsibility of the purchaser. If MSI determines that the product is covered by this limited warranty, it will only pay for parts and labor as indicated by product type. If MSI determines that the product is not covered by this limited warranty, the purchaser will have the option of paying for the repair (if the product can be repaired) and the purchaser shall be responsible for the cost of shipping the repaired product back to the purchaser. MSI reserves the right, in its sole and absolute discretion, to decline any repair.

IN NO EVENT SHALL MEGA SYSTEMS, INC. BE LIABLE FOR ANY INCIDENTAL, CONSEQUENTIAL, SPECIAL, INDIRECT OR PUNITIVE LOSS OR DAMAGE OF ANY KIND, INCLUDING, BUT NOT LIMITED TO, LOSS OF PROFITS OR REVENUES, LOSS OF USE OF THE PRODUCT OR ANY OTHER GOODS OR ASSOCIATED EQUIPMENT, DAMAGE TO ANY ASSOCIATED EQUIPMENT, COST OF CAPITAL, COST OF SUBSTITUTE PRODUCTS, FACILITIES OR SERVICES, DOWNTIME COST, INSTALLATION OR LABOR COSTS, OR CLAIMS OF THE PURCHASER'S CUSTOMERS, WHETHER BASED ON WARRANTY, CONTRACT OR NEGLIGENCE, ARISING IN CONNECTION WITH THE SALE, USE OR REPAIR OF THE PRODUCT. MEGA SYSTEMS INC'S MAXIMUM LIABILITY SHALL NOT, IN ANY CASE, EXCEED THE PURCHASE PRICE OF THE PRODUCT THAT GIVES RISE TO THE CLAIM.

EXCEPT FOR THE LIMITED WARRANTY SET FORTH HEREIN, ALL PRODUCTS SOLD BY MEGA SYSTEMS, INC. ARE SOLD "AS IS" WITHOUT ANY WARRANTY, EXPRESS OR IMPLIED, STATUTORY OR OTHERWISE, INCLUDING, BUT NOT LIMITED TO, IMPLIED WARRANTIES OF MERCHANTABILITY AND FITNESS FOR A PARTICULAR PURPOSE, ALL OF WHICH ARE EXPRESSLY AND SPECIFICALLY DISCLAIMED BY MEGA SYSTEMS, INC.

Customer Support

MEGA Lite has a customer support line to provide set-up help and to answer any questions should you encounter a problem. Please visit our website for any other related technical documents. For service related issues, please contact our service dept.

Monday - Friday 9am to 6pm CST
(210) 684-2600
service@mega.lighting

Manual Version

Please visit www.mega.lighting for the most up-to-date manual version.

Manual Version	Date	Fixture Software	Notes
1.0	9/09/2024	1.0	



MEGA LITE
18662 Bandera Rd
Helotes, TX 78023
Phone (210)684-2600 / Fax (210)855-6279
www.mega.lighting / info@mega.lighting